

# RF/MW thermal ablation for cancer treatment

Electromagnetic fields at RF/MW frequencies are used to obtain very high temperature increases in the tissue ( $> 60\text{ }^{\circ}\text{C}$ ) to induce coagulative necrosis of malignant cells

## Applications:

- cardiac arrhythmias,
- endometrial disorders,
- tumours,
- .....



Radiological Society of North America (RSNA)

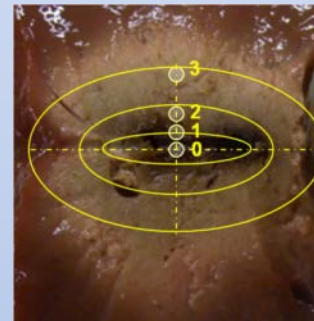

Lopresto et al, Phys. Med. Biol., 2012

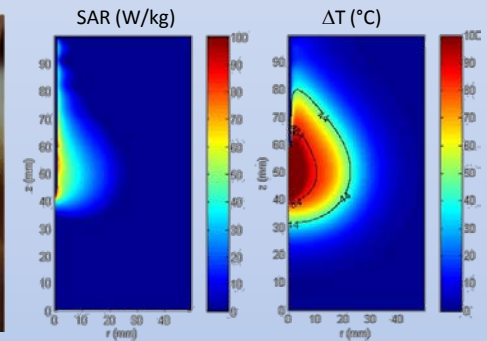

Cavagnaro et al., BioEM Conf., 2013

## Research on predictive models for treatment planning

ENEA UT BIORAD (V. Lopresto, R. Pinto), DIET Sapienza (M. Cavagnaro)

- Experimental methodologies for characterization of RF/MW thermal ablation process
- Investigation on dielectric, thermal and morphologic properties of tissues
- Numerical predictive models for treatment planning

## Research on inflammatory response induced by RF/MW thermal ablation

ENEA UT BIORAD (C. Pioli, F. Novelli)

- Investigation on inflammatory process and immune response induced by thermal ablation

# Dosimetry

ENEA UT BIORAD (R. Pinto, V. Lopresto)

## Experimental

### SAR test bench

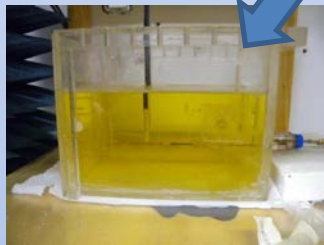
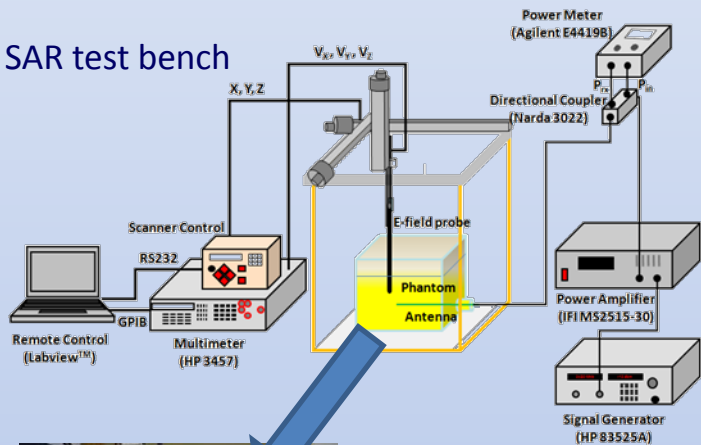

Phantoms development

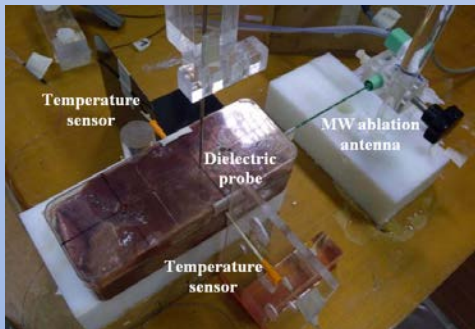

Dielectric measurements  
Thermal dosimetry

Lopresto et al, Phys. Med. Biol., 2012

## Numerical

### Full-3D EM simulation (from ELF to MW)

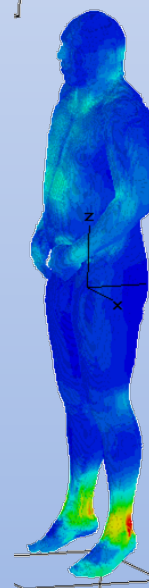
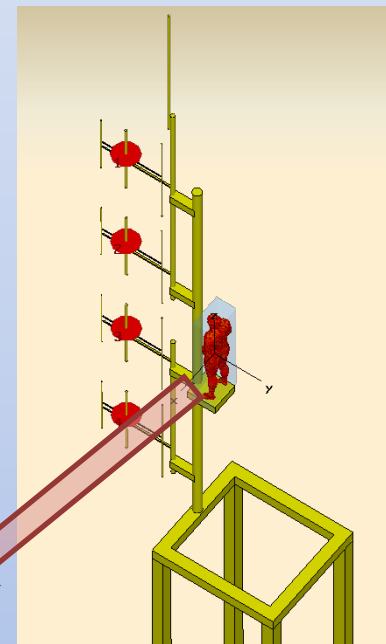

Digital anatomical models  
(animals & humans)